

## Fire-Rated, Security-Rated Narrow Profile Steel Door System

### Fire-Rating: 20-60 Minutes

Fireframes Designer Guard System features a die-rolled steel profile swinging door with sidelite(s) and is the first fire-rated full-lite door system certified to forced entry standards in North America. The attack-resistant system has the appearance of a narrow-profile aluminum storefront door and is ideal for school applications, detention centers, institutional buildings and anywhere a security-rated door system is required. A sleek alternative to typical hollow metal doors, Fireframes Designer Guard System features precise edges, professional finish, and the narrowest sightlines available with a fire rating. Pre-hung, pre-finished and easy to install, Fireframes Designer Guard System complements adjacent non-fire-rated doors and provides a high level of forced entry attack resistance and security.

### FEATURES

- Fire ratings for 20-60 minutes with **required hose stream test**
- Intertek certified system tested to ASTM E2395
- Meets HP White 5-aa10
- Impact safety-rated – meets ANSI Z97.1 and CPSC 16 CFR1201 (Cat. I and II)
- Single door and sidelite(s) assembly
- Narrow steel profiles provide a seamless aesthetic with adjacent non-fire-rated doors in a given project
- Durable welded steel construction of door
- Pre-hung, prefinished, with system specific hardware included
- Finish powder coating at the factory to match desired color scheme
- Installs into a finished opening
- Glazing consists of FireLite Plus® Forced Entry IGU. If you are looking for fire-rated security glass, please visit FireLite Plus® Forced Entry

### LISTINGS/STANDARDS

#### Intertek Listings:

Frame and Door tests for Forced Entry Certified (Spec ID 62659) W/N 22992 with Intertek I Warnock Hersey to:

AAMA 1304	ASTM E1886	ASTM E2395
	ASTM E1996	ASTM F476
	ASTM E2025	ASTM F588







#### UL Listings:

Classified and labeled by Underwriters Laboratories, Inc.® and Underwriters Laboratories of Canada. File numbers R25229 (Fire Protection Rating) and R19207. FireLite products have been tested to BS 476-20 up to 4 hours for 1.21 m x 2.43 m and .91 m x 2.43 m dimensions. Tests performed in accordance with:

ASTM E2010	UL 9	NFPA 80	CAN/ULC-S104	BS 476-20
ASTM E2074	UL 10B	NFPA 251	CAN/ULC-S106	
	UL 10C	NFPA 252		
		NFPA 257		

### SPECIFICATIONS

Complete 3-part CSI format specifications are available online at [fireglass.com](http://fireglass.com), or by calling 800.426.0279.

-  Intertek Listed & Labeled
-  UL Classified & Labeled
-  Fire-Rated
-  Hose Stream Tested
-  Impact-Rated
-  Positive Pressure Tested
-  Forced Entry Resistant

## ASSEMBLY

SINGLE DOOR*	RATINGS	MAX. WIDTH	MAX. HEIGHT
Max. Door Leaf Size	20-60 min.	36-3/4" (933 mm)	95-7/8" (2,435 mm)
Max DLO Glass	45-60 min.	29-1/2" (749 mm)	88-3/4" (2,254 mm)

\*Glazed with FireLite Plus® Forced Entry IGU

SIDELITE	RATINGS	MAX. WIDTH	MAX. HEIGHT
Overall Assembly - Single Sidelite	45-60 min.	79-1/2" (2,019 mm)	98" (2,489 mm)
Overall Assembly-Multiple Sidelites	45-60 min.	162" (4,114 mm)	98" (2,489 mm)

Note: When using more than one sidelite, individual sidelites cannot be wider than the door.

## DOOR / SIDELITE DETAILS

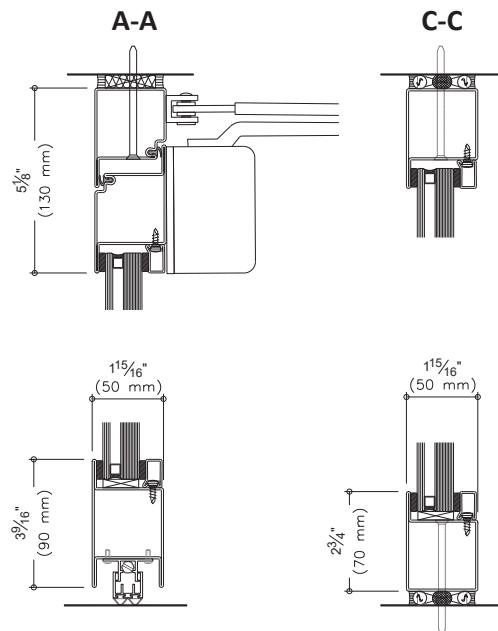
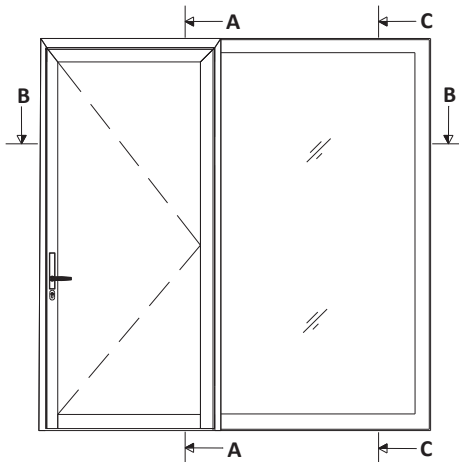

## HARDWARE

All system hardware for Fireframes Designer Guard System is supplied and factory installed by Technical Glass Products.

System specific hardware includes:

- WSS Mortise Lock
- Weld On Pivot Hinges by TGP
- LCN 4040 Series Closer
- Tall bottom rail (optional)

